

Test Jacket - Galiso P/N 01-41-3201

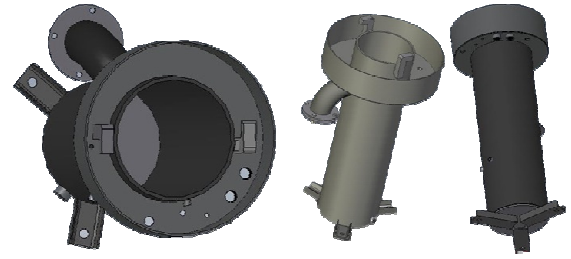

Reservoir Shield

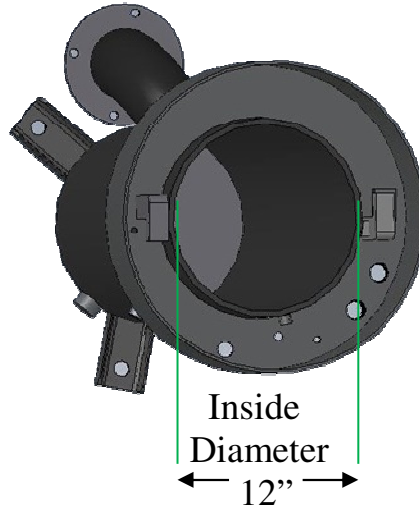

PO Box 1468
Montrose, CO 81401

www.galiso.com (800)854-3789



Available in Stainless

Max Cylinder Dimension 12" Jacket

A = 68.5inches/82.5cm B = 11inches/28cm

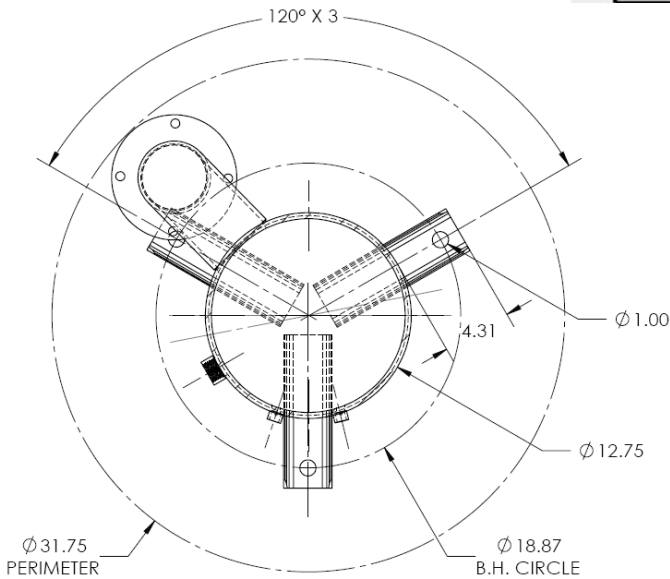
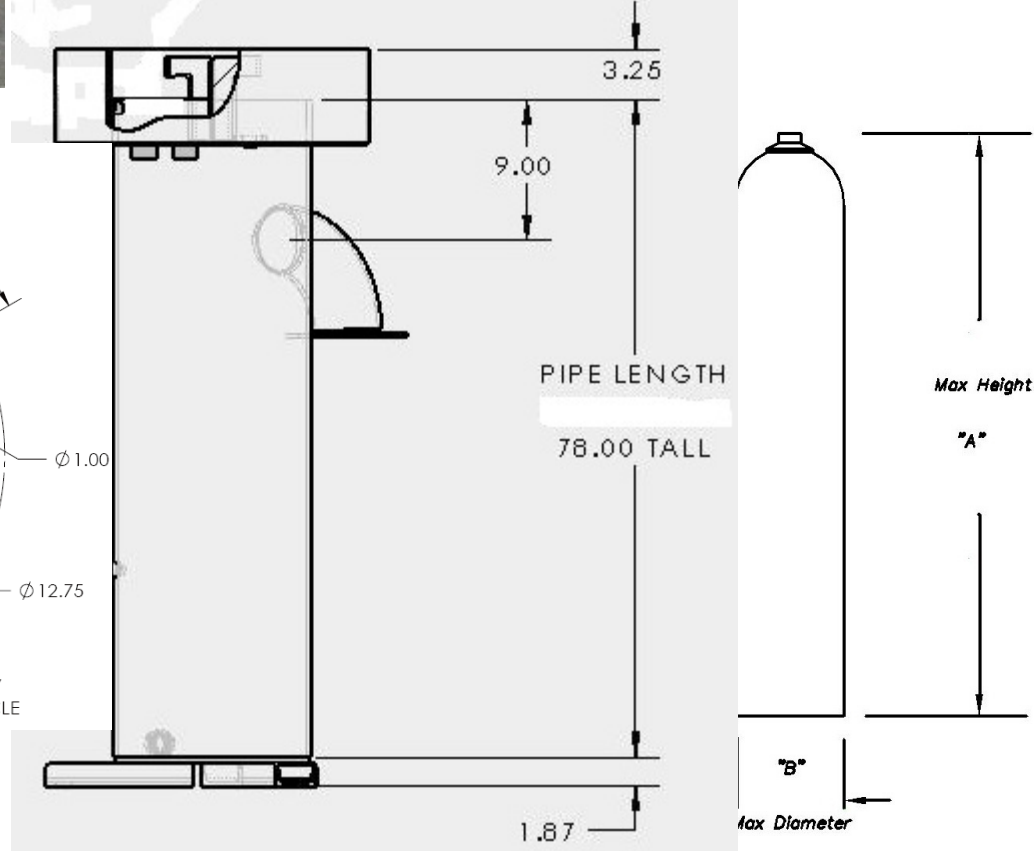

The Hydraclose Test Jacket contains a safety locking device, one or more burst disk crystals, (depending on the diameter of the jacket), a drain valve, a basin splash shield and connection hoses that attach to the Hydraclose Test Head.

- Reservoir Shield diverts the water down 2 1" NPT pipe nipples that can be plumbed directly to drain. Reservoir shield prevents water on the sides of the jacket which has a significant effect on expansion and can delay test results due to instability.
- The Hydraclose Test Jacket is available in 12", 14", 18", 24", 30' & 36" nominal diameters.