

---

# SCD

**SMALL CYLINDER DRYER  
with Touchscreen Controller**

## **INSTRUCTION MANUAL**

---



**MANUAL NUMBER 21-11-1042**

**Issued March 2015**

---

**Copyright 2015, Galiso, Inc.  
22 Ponderosa Ct., Montrose, CO 81401  
(970) 249-0233 (800) 854-3789  
[www.galiso.com](http://www.galiso.com)**

---

**Revision E Issued March 2015**



**!!!DANGER!!!**

**DO NOT USE THIS EQUIPMENT TO  
PURGE TOXIC OR FLAMMABLE GAS**

**AND**

**DO NOT USE THIS EQUIPMENT UNDER  
FLAMMABLE, VOLATILE OR TOXIC  
ENVIRONMENTAL CONDITIONS**

---

## TABLE OF CONTENTS

Section/Title	Page
1.0 Introduction .....	1-1
2.0 Specifications.....	2-1
3.0 Safety.....	3-1
4.0 Installation.....	4-1
4.1 Receiving and Placement.....	4-1
4.2 Plumbing Connections.....	4-1
4.3 Detergent Supply.....	4-2
5.0 Operation .....	5-1
5.1 Control Panel Components.....	5-1
5.2 Control Settings .....	5-2
5.3 Operation Process.....	5-2
6.0 Maintenance .....	6-1
6.1 Detergent Reservoir (SRC-1), Filling .....	6-1
6.2 Detergent Supply Shutdown .....	6-1
6.3 General Maintenance .....	6-2
6.4 Troubleshooting.....	6-2
7.0 Spare Parts.....	6-2

### List of Tables and Figures

Number/Title	Page
Figure 1, SCD-4 Small Cylinder Dryer .....	2-1
Figure 2, Detergent Supply SRC-1.....	4-2
Figure 3, SCD Control Panel and Plumbing .....	5-1
Figure 4, Main Operation Menu.....	5-3
Figure 5, Setting Timers Menu.....	5-3
Figure 6, Drain Air Timer.....	5-4
Figure 7, Timer Entry Keypad .....	5-4
Figure 8, Process Screen.....	5-5
Table 1, Spare Parts .....	6-2

---

## 1.0 INTRODUCTION

The SCD-4 has been designed to quickly wash, drain and dry, up to four (10" diameter x 30" length) cylinders in less than 2 minutes.

The SCD-4 utilizes compressed air and hot water to drain and flash dry compressed gas cylinders, after hydrostatic testing.

A Control Box contains a Touch Screen to provide quick and easy controls with a range of custom times for each process.

The time ranges available for each process are listed below:

Drain Air: 1 - 999 seconds  
Hot Water: 1 - 999 seconds  
Detergent: 0 - 999 seconds  
Dry Air: 1 - 999 seconds

The SCD series dryer electrical requirement is: 100-240 Volt 47-63 Hz.

This page intentionally left blank.

## 2.0 SPECIFICATIONS

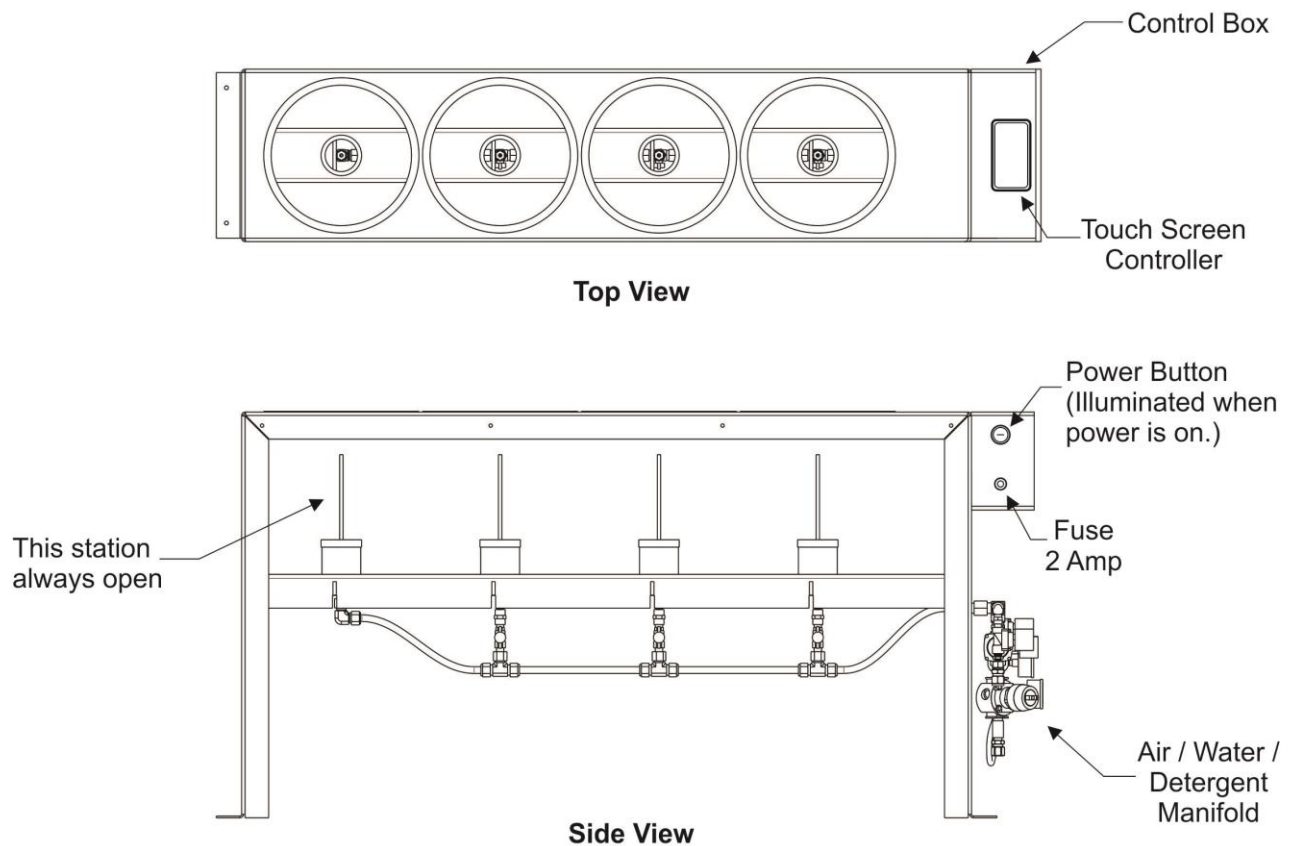

**Figure 1, SCD Small Cylinder Dryer**

Dimensions: 60" Long x 13" Wide x 30" High

Power Requirements: 100 - 220 Volt, 47-63 Hz 12Vdc 2.5Amp

Capacity: up to 4 Cylinders.

Maximum Cylinder Size: 10" maximum diameter: up to 30" tall, 45 lbs maximum

Operating Air Requirements: <1.0 cfm @ 90 psig Shop Air Supply

Drying Air Requirements: 10.0 cfm @ 90 psig with < 0.03 ppm contaminant

(Galiso recommended for oxygen maintenance: filter package number 80-11-0046 with a 0.01 ppm)

Hot Water Requirements: 5.0 gpm @ 60 psig, 180° F maximum

Warranty: One Year (see Galiso Warranty Terms, Form No GSO7805-1).

This page intentionally left blank.

### 3.0 SAFETY

Read all instructions before attempting to install or operate this machine. GALISO, INCORPORATED IS NOT RESPONSIBLE FOR DAMAGE OR INJURY CAUSED BY UNSAFE USE, MAINTENANCE, APPLICATION, MODIFICATION OR IMPROPER INSTALLATION OF THIS MACHINE. Please contact Galiso, Inc. for guidance when you are in doubt as to the proper safety precautions to be taken when installing or operating this machine.

- A. Take care to keep the work area around the SCD clean, dry and free of debris. This will decrease the chance of operator injury due to slips or falls.
- B. Always wear gloves, eye protection and foot protection while operating the SCD.

**CAUTION:**

The SCD dryer is capable of producing considerable heat. Dried Cylinders can heat up to 180°F. Use insulating gloves to protect hands against possible burns from hot areas and items.

- C. When one or more of the injection probes is not in use, the operator must verify that the inlet valve(s) to the unused station(s) is shutoff.

**! WARNING !**

**Operation of the SCD without isolating unused stations, may result in a burn injury due to uncontrolled hot water (180°F) being discharged. Should this occur, press the Stop Button immediately to terminate the operating cycle.**

- D. Make sure to bolt, lag or clip the GCD securely to the floor.
- E. Do not use lubricated air to operate the drying air. This system requires the use of clean, dry, oil-free air ONLY.
- F. When placing a cylinder into the station, be careful to not strike the probe with the cylinder. The Injection Probe(s) could be bent or deformed, or bumping may cause damage to the neck threads and/or sealing surfaces of aluminum cylinders.

**CAUTION:**

After any cycles have been run, the operator should be careful to avoid touching the Manifold Frame, as it may remain hot for a short time.



This page intentionally left blank.

---

## 4.0 INSTALLATION

Read all instructions and familiarize yourself with the installation blueprints before attempting to install or operate the SCD Small Cylinder Dryer.

### 4.1 Receiving and Placement

- A. Carefully uncrate the SCD Cylinder Dryer and remove all packing materials.

If there are any missing or damaged parts, please call Galiso, Inc. at 1 (800) 854-3789 and DO NOT attempt to install any pieces until concerns and possible safety issues have been discussed.

- B. The installation location should insure adequate clearance for unprotected shop personnel, and close to the power outlet.
- C. The SCD placement should be as close as possible to the hot water source to maximize the heat input to the cylinder(s).
- D. The installation location must also, provide for suitable drainage.
- E. After the dryer has been placed in its desired location, bolt, lag or clip to the floor.

### 4.2 Plumbing Connections (refer to Figure 3 for connection locations)

Do not use lubricated air.

- A. Drying Air (for cylinder injection): Connect a clean, dry, oil free air supply to the Clean Air In Port on the SCD Unit (see Fig. 3, Section 5-1). This air supply must provide up to 10 cfm, with a purity of less than 0.3 PPM contaminant.
- B. Drain Air Supply: Connect a “shop air supply” to the Shop Air In Port on the filter/regulator assembly. The shop air regulator should be set at 20 psig.
- C. Hot Water Supply: Connect a 60 psig water supply to the unit capable of delivering up to 5 gpm @ 180°F.

## 4.0 INSTALLATION, continued

### 4.3 Detergent Supply:

A detergent supply system (SRC-1) is required to utilize the SCD wash option. The Galiso standard detergent supply system consists of a compressed air supply line and valve, a detergent supply line, dip tube and control valve. Any clean, low pressure cylinder with a 3/4" NPT neck opening may be used with the SRC-1 to form the Detergent Supply Reservoir. Certain types of detergents and cylinder cleaning solutions are not compatible with aluminum cylinders. Galiso, Inc. recommends using a steel cylinder as the Detergent Reservoir. Suitable Detergent Supply Reservoir Cylinders are also available from Galiso.

- A. Trim the bottom of the SRC-1 Dip Tube to fit the cylinder that is being used as the Detergent Reservoir. The length of the Dip Tube should allow approximately 3" between the base of the Dip Tube and the bottom of the cylinder when the SRC-1 is installed in the cylinder neck. See figure 2, below.

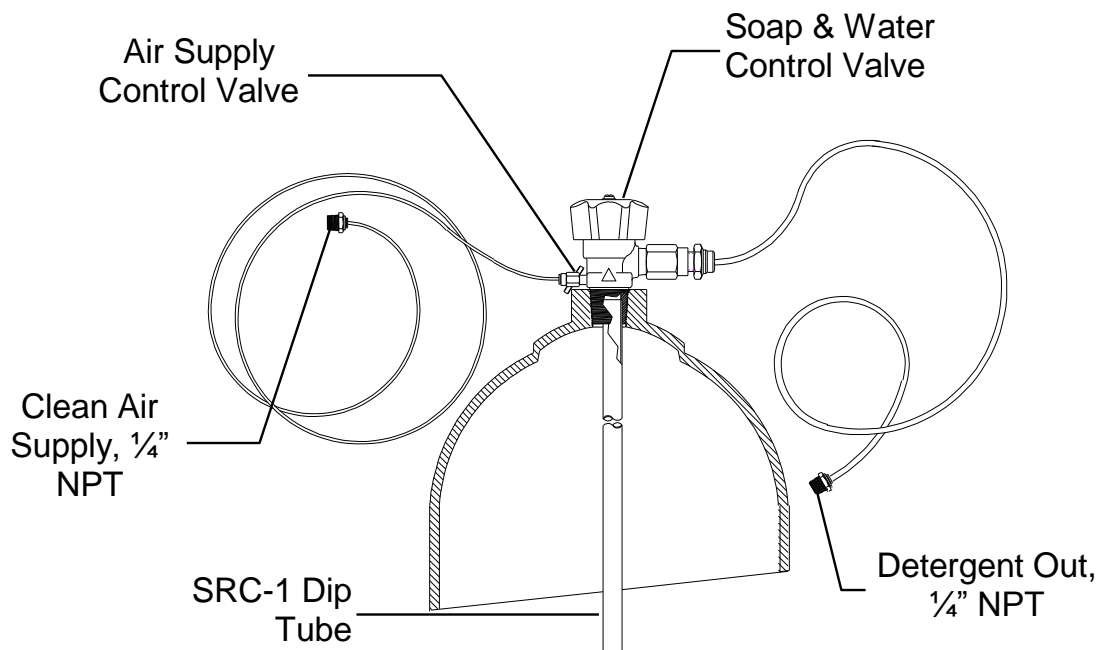

**Figure 2, Detergent Supply SRC-1**

- B. Fill the cylinder with a suitable, oxygen compatible detergent or cleaning solution. The level of the detergent should be 6" below the bottom of the threads in the cylinder neck. Use an oxygen compatible, liquid degreaser, water soluble soap such as SD-13 which is available from Galiso, Incorporated at (800) 854-3789 or visit the website [www.galiso.com](http://www.galiso.com).

---

## 4.0 INSTALLATION, continued

### 4.3 Detergent Supply, continued

- C. Teflon tape the threads on the base of the SRC-1 and screw the SRC into the neck of the Detergent Reservoir cylinder. Close the Soap and Water Control Valve and the Air In Control Valve.
- D. Connect a supply line from the Detergent Out Port on the SRC-1 to the Detergent In Port on the SCD.
- E. Connect a supply line from the Clean Air Port on the SRC to a source of clean, filtered air. Air used to operate the Detergent Supply Reservoir should have a contaminant level less than 0.03 parts per million. The Detergent Reservoir Clean Air Supply Line can originate from the clean air source that is used supply clean air to the SCD. A filter system is available from Galiso which will clean the air to a contaminant level of 0.01 parts per million. The Detergent Reservoir clean air supply line should be equipped with a regulator, set at 80 psi.
- F. Open the Air In Control Valve and allow the Detergent Reservoir to build pressure. Open the Soap and Water Control Valve.

It may be necessary to adjust the Soap and Water Control Valve to achieve the appropriate detergent flow for the size of cylinders that you are servicing. If the cylinders are consistently dirty after cleaning, open the Soap and Water Control Valve slightly. If a detergent residue remains after rinsing, close the Soap and Water Control Valve slightly.

This page intentionally left blank.

## 5.0 OPERATION

### 5.1 Control Panel Components and Plumbing:

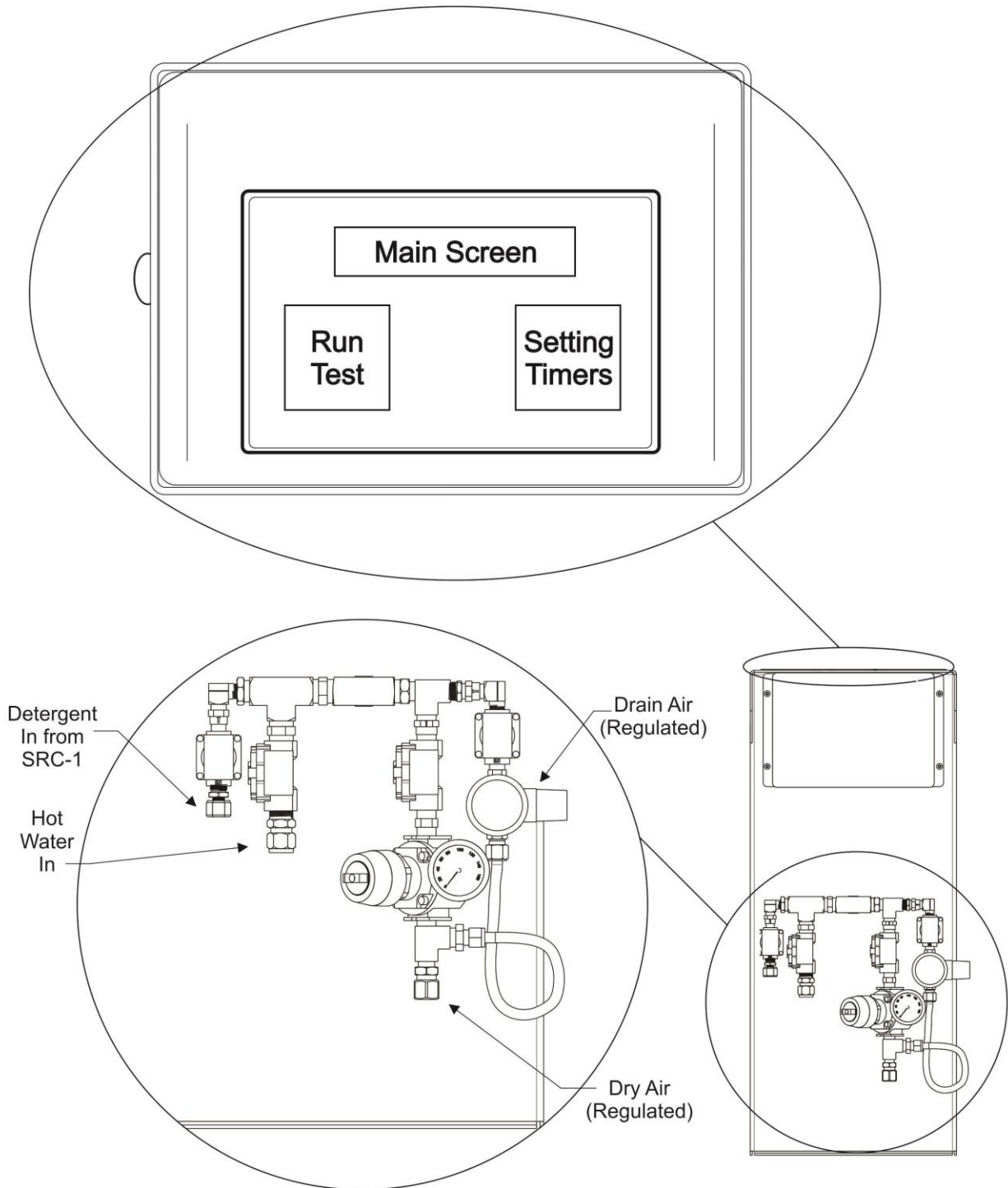

**Figure 3, SCD Control Panel Components and Plumbing**

## 5.0 OPERATION, continued

### 5.2 Control Settings:

The SCD has been equipped with an easy to use Touch Screen Controller. The Power Switch and Touch Screen Controller are located on the top of the Electrical box. Individual times can be set from 0 to 60 seconds for each function, dependent upon cylinder size and material. Following is an example to be used as basic times, although, times should be determined by the operator or supervisor to account for cylinder type and size.

**Example:**

Processing Medical E aluminum cylinder, 4 ½" Diameter, 25 in. Length

**Drain Air:** 3-5 seconds. Drain Air purges cylinder(s,) of any remaining water and is normally a relatively short cycle.

**Detergent:** Set at 0, unless the Detergent cycle is needed.

**Hot Water:** Set at approximately 20 seconds.

**Dry Air:** 30 seconds.

**Water:** 3/8" Polyline at street pressure

**Dry Air:** Regulated at 90 psig minimum

**Drain Air:** Regulated at 20 psig maximum

### 5.3 Operation Process:

- A. Always close any of the Inlet Valves to all stations that will not be used.

**! WARNING !**

**Operation of the SCD without isolating unused stations, may result in a burn injury due to uncontrolled hot water (180°F) being discharged. Should this occur, press the Stop Button immediately to terminate the operating cycle.**

- B. Check that the cylinders are emptied and drained of water.
- C. Invert drained cylinder and place upside down with an Injection Probe inserted into the cylinder neck.
- D. Always load the first cylinder into the Station furthest from the Control Panel, or load into this Station when only processing one cylinder. The Station furthest from the Control Panel is always open and cannot be shut off.

**CAUTION:**

Avoid bending or otherwise damaging the tube. Caution should also be used to avoid damage to the neck of the cylinders.

**5.0 OPERATION, continued**

- E. If unused Inlet Valves are closed and control times have been set, turn the Power Switch to the ON position. The Button will be illuminated red when power is in the ON position.
- F. The first screen to appear after the machine has been powered on is the Home or Main Screen menu. See figure 4, below.

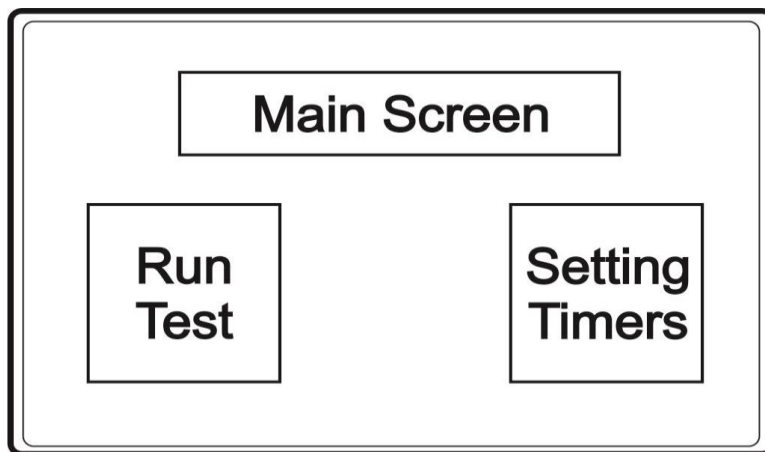

**Figure 4, Main Operation Menu**

- G. Press “Setting Timers” to set the desired times for each function. The following menu will show, allowing the operator to view or change times for the 4 functions.

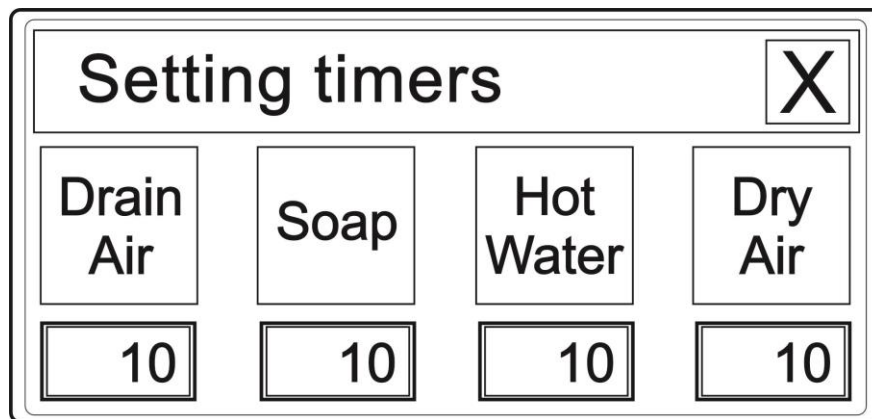

**Figure 5, Setting Timers**

- H. The numbers displayed show the current time settings for each process. See steps J-L to make changes to the time values.



**5.0 OPERATION, continued**

- I. Upon pressing “Dry Air”, the following menu will show.

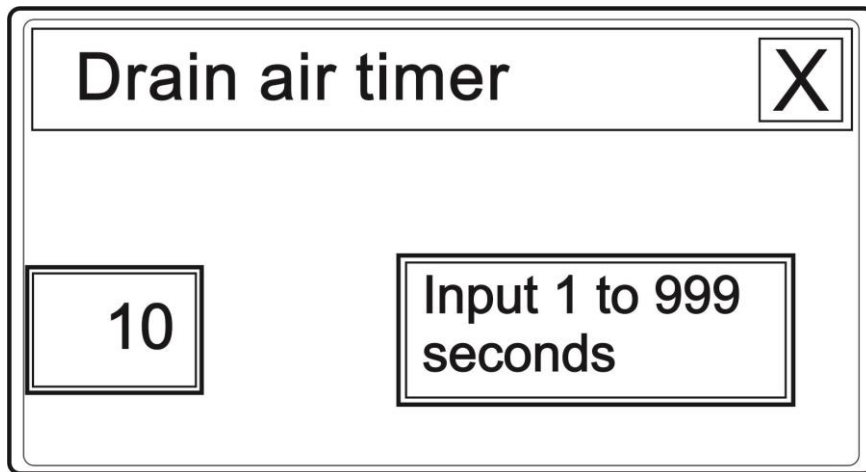

**Figure 6, Drain Air Timer**

- J. Touch inside of the yellow box on the left and a numeric keypad will now show to the right of the yellow box. Enter the desired time for the Drain Air to be injected and press ENT, to enter the set time.

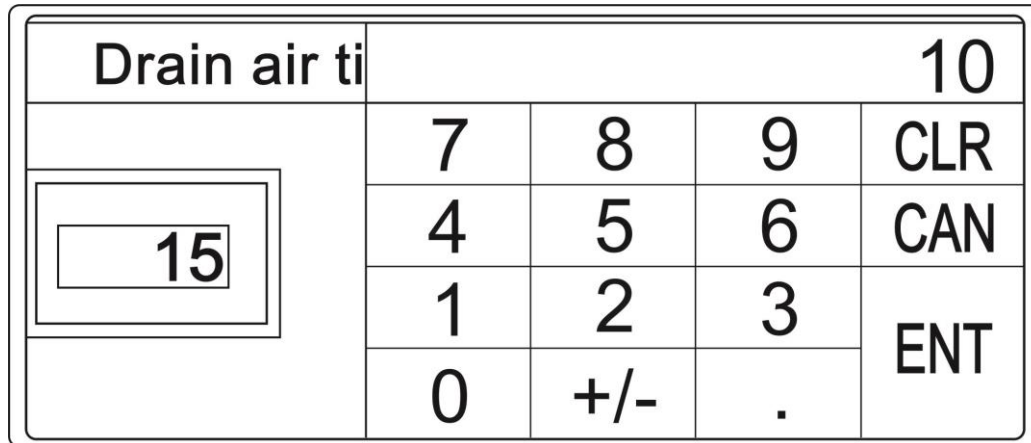

**Figure 7, Timer Entry Keypad**

- K. Once ENT has been pressed, press the X in the upper right-hand corner to return to the Drain Air Timer menu (figure 6). Press X again to return to the Setting Timers menu.
- L. Repeat steps H-J, for Soap Injection (SOAP), Hot Water Injection (HOT WATER), and hot Dry Air (DRY AIR) timer entry, selecting appropriate injection choice.
- M. Once all times have been entered, press the X 2 or 3 times, until reaching the Main Screen (figure 4).

## 5.0 OPERATION, continued

- N. Press the Green Box that reads “Run Test”. A screen will show displaying each process and run time as each operation is performed. The system will now automatically start and cycle through all the processes.

NOTE: The time entered will be displayed as each operation starts. The Timer will “count down” as the operation progresses.

Value in seconds				X
0	Drain air	Hot water	4	Run
0	Soap	Dry air	0	Abort

Figure 8, Process Screen

- O. Press “Abort” at any point during operation, to immediately stop all processes. Press “Run” to restart operation. The machine will restart processes, beginning at the Drain Air operation.
- P. After cylinders have finished drying, check each cylinder for dryness. If cylinders are not dry enough, increase the Dry Time. Remember that the cylinders will likely be hot!

### CAUTION:

Cylinders and the Manifold Frame may be hot. Galiso, Inc. recommends insulated gloves are worn when changing out cylinders to help prevent burns.

This page intentionally left blank.

---

## 6.0 MAINTENANCE

### 6.1 Detergent Reservoir (SRC-1), Filling

To refill the Detergent Supply Reservoir, proceed as follows;

- A. Close the Clean Air In Control Valve and the Clean Air Supply Regulator to the Detergent Reservoir located on the SRC-1.
- B. Remove the Clean Air In and the Detergent Supply lines from the SRC-1.
- C. Open the Clean Air In Control Valve on the SRC-1 and allow all air pressure to escape from the Detergent Supply Reservoir. Close the Valve when the air pressure has been fully released.

**CAUTION:**

Be certain that all air pressure has been released before removing the SRC-1 Detergent Reservoir Control Valve from the cylinder.

- D. Remove the SRC-1 from the cylinder neck and refill the Detergent Supply Reservoir.
- E. Return the SRC-1 into the cylinder neck and open the Clean Air In Valve and the Clean Air Supply Regulator.

### 6.2 Detergent Supply Shutdown

At the end of each period of operation, shut the Detergent Reservoir as follows;

- A. Close the Detergent and Water Control Valve. Close the Clean Air In Control Valve.
- B. Close the Detergent Reservoir Clean Air supply line Regulator.
- C. Remove the Detergent Reservoir Clean Air Supply Line from the SRC-1 and open the Clean Air In Control Valve and allow all pressure to bleed from the reservoir.
- D. Replace the Detergent Reservoir Clean Air Supply Line after all pressure has escaped from the Detergent Reservoir.
- E. Close the Clean Air In Control Valve.

## 6.0 MAINTENANCE, continued

### 6.3 General Maintenance

- A. Check the Air Supply Line Filter daily for proper operation and drain as needed.
- B. If compressed air is used for injection, check filters daily for proper operation.
- C. Galiso, Inc. recommends that the Air Filter Element be replaced every six (6) months. The Air Filter Element (part number 80-11-0068) may be purchased from the Galiso, Inc.

### 6.4 Troubleshooting

- A. Contact a Galiso, Incorporated representative at 1 (800) 854-3789 for assistance in troubleshooting and/or ordering replacement parts.

## 7.0 SPARE PARTS

**Table 1, Spare Parts**

Item	Part No.	Description
A.	25-41-3134	Control Box
B.	88-11-0089	Fuse 2 Amp
C.	93-11-1066	Power Supply, 100-240 VAC to 24Vdc 2.5Amp
D.	83-11-2012	Cylinder Valve, Soap Injection
E.	81-11-0364	2-Way Valve, 1/4"
F.	81-11-0365	2-Way Valve, 3/8"
G.	81-11-0368	2-Way Valve, 1/2"
H.	81-11-1203	Valve, 1/4" mini
I.	83-11-0022	Check Valve, 1/2" Circle Seal
J.	83-11-0031	Check Valve, 1/4"

If unit has a Basin and / or Curtains:

A.	25-41-3193	Basin Tray
B.	25-31-3193	Splash Curtain w/ Logo

1. **DURATION:** Galiso provides a one-year warranty from date of purchase, to the original purchaser, for standard products, unless otherwise specified. For all spare parts purchases, Galiso provides a 90-day warranty unless otherwise specified. Soft goods such as our speed seals, and O-rings, which are subject to wear in the normal course of operation, are not covered under this warranty.
2. **COVERAGE:** Galiso manufactured equipment is warranted against defective materials or workmanship. THIS WARRANTY IS VOID IF:
  - A) THE EQUIPMENT HAS BEEN DAMAGED BY ACCIDENT OR UNREASONABLE USE, IMPROPER SERVICE/MAINTENANCE, IMPROPER INSTALLATION, ABNORMAL OPERATING CONDITIONS, NEGLIGENCE, REPAIR BY ANY PERSON NOT AUTHORIZED BY GALISO, INC. OR OTHER CAUSES NOT RELATED TO MATERIAL DEFECTS OR WORKMANSHIP.
  - B) THE SERIAL NUMBER HAS BEEN ALTERED OR DEFACED.
3. **PERFORMANCE:** Galiso reserves the right to make warranty determination only after inspecting the item at the Galiso manufacturing facility. If the warranty determination indicates that the defective item is covered under warranty, the item will be repaired or replaced with the same parts/items or parts/items of equivalent quality, at the option of Galiso. In the event of replacements, the replacement unit will continue under the original equipment warranty or carry a 90-day warranty, whichever is longer. No charge will be made for warranty repairs, and/or replacements. All freight charges to and from Galiso Inc. or a Galiso Inc. authorized repair facility, are the responsibility of the customer requesting warranty service.

If the warranty determination indicates that the item is **not** covered by warranty, a repair/replacement cost estimate will be submitted to the customer/purchaser for approval prior to initiating any repair work.

4. **CLAIMS:** In the case of equipment malfunction, notify Galiso (1-800-854-3789) and provide the Model Name, Model Number, Serial Number and a description of the problem. Return Authorization Number, shipping and/or service information will be provided on receipt of the required information.
5. **SERVICE EQUIPMENT:** Galiso attempts to make available, whenever possible, a limited amount of service equipment at a minimal use charge, plus freight expense, for those customers wishing to avoid downtime during repair of their equipment. Such items are available on a first come, first served basis and are billable at the specific service charge applying with a one-month minimum.
6. **MODEL CHANGES:** Galiso reserves the right to make changes in materials and specifications, without notice. Galiso may offer, for a stipulated fee, the opportunity to upgrade your equipment to the latest configuration.
7. **DISCLAIMERS:** Galiso provides technical data and assistance to aid customers in the selection and use of our products. There are no implied warranties of merchantability nor suitability for a particular purpose associated with the transmittal of technical data and/or customer assistance.

Galiso does not assume liability for any consequential, incidental, or special damages. Liability under this warranty is limited to repairing, or replacing Galiso equipment items returned to the factory or an authorized facility.

8. **COMPUTER AND NETWORK VIRUS PROTECTION:** Galiso Inc. equipment, which utilizes internet access, comes equipped with a subscription to virus protection software. It is the responsibility of the equipment owner to maintain this virus protection subscription or other virus protection at their cost. Current virus subscriptions are mandatory to maintain the benefits of this warranty. Galiso does not assume liability for any or all damages related to or are the result of internet or network failure or malware or computer viruses or any other type of internet or network malfunction or attack.